



BASgatewayLX — Modbus to BACnet® Converter

The BASgatewayLX makes Modbus device commissioning fast and easy thanks to pre-built device profiles and virtual routing. Modbus remains a popular network interface, and is commonly found on jobs such as boiler control, variable speed drives, and metering applications, but these devices lack BACnet compliance. To make Modbus devices appear as individual BACnet devices a BASgatewayLX is used. This device has one 10/100 Mbps Modbus TCP and BACnet/IP Ethernet port and an opto-isolated Modbus EIA-485 serial port for Modbus RTU or Modbus ASCII devices. A total of 100 Modbus serial or TCP devices, represented by up to 1000 points can be made visible to the BACnet network by using a BASgatewayLX. BACnet COV notification is supported on 200 points (100 Analog and 100 Binary points). The virtual routing feature in the BASgatewayLX allows each connected Modbus device to appear as an individual BACnet compliant device. What is needed is a device profile for each Modbus type device. Contemporary Controls maintains a library of common device profiles available for download here: www.ccontrols.com/profiles.

Gateway Functionality Between ...

- Modbus Serial (RTU or ASCII) and BACnet/IP
- Modbus TCP and BACnet/IP

Routing Functionality Between...

- Modbus Serial (RTU and ASCII) and Modbus TCP

Flexible Communication Ports

- 10/100 Mbps Ethernet with auto-negotiation and Auto-MDIX
- Opto-isolated serial port supports either 2-wire or 3-wire EIA-485
- Jumper-selectable EIA-485 bias and termination
- Baud rates from 2.4–115.2 kbps

Convenient Installation

- 24 VAC/VDC powered
- DIN-rail mount (BASGLX-M1) or panel mount (BASGLX-M1/P)

If the device profile is not available, Contemporary Controls will provide it upon request. Custom Modbus device profiles can also be uploaded to the BASgatewayLX using the web page.

Up to 100 Modbus serial devices (represented by up to 1000 polled points) can share the single Modbus EIA-485 port on the BASgatewayLX.

Using web pages and a resident database of common Modbus device profiles, Modbus data points from Modbus Serial or Modbus TCP devices are mapped to BACnet objects.

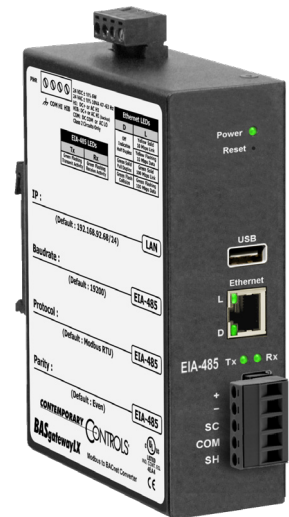

BASgatewayLX — Modbus to BACnet Gateway

The BASgatewayLX is housed in a metal case that mounts on 35-mm DIN-rail, or panel mounts, depending on the option chosen, and it is powered from a 24 VAC/VDC ($\pm 10\%$) source. Its half-wave rectified power supply allows sharing of power with other half-wave devices.

The optically-isolated serial port allows for connection to either 2-wire or 3-wire EIA-485 networks using a removable 5-pin terminal block. Up to 100 EIA-485 Modbus devices can share the serial bus at data rates between 2.4 and 115.2 kbps. Internal jumpers allow flexible bias and termination options. They can be removed for mid-span installations.

The Ethernet port offers a shielded RJ-45 connector. Through auto-negotiation and Auto-MDIX, it automatically

matches connections to the attached equipment. Therefore, either CAT5 straight-through or crossover cable can be used to attach to the BACnet/IP or Modbus TCP network at either 10 or 100 Mbps speed.

A resident web server allows for configuration, device status, and Modbus Utility operations using any standard web browser. HTML web pages allow cross-platform compatibility and browser support. A push button at the front is provided to return the unit to the factory default IP address of 192.168.92.68 /24 and credentials of: username: *admin* and password: *admin*. LED indicators provide communication status on both the Ethernet and serial ports.

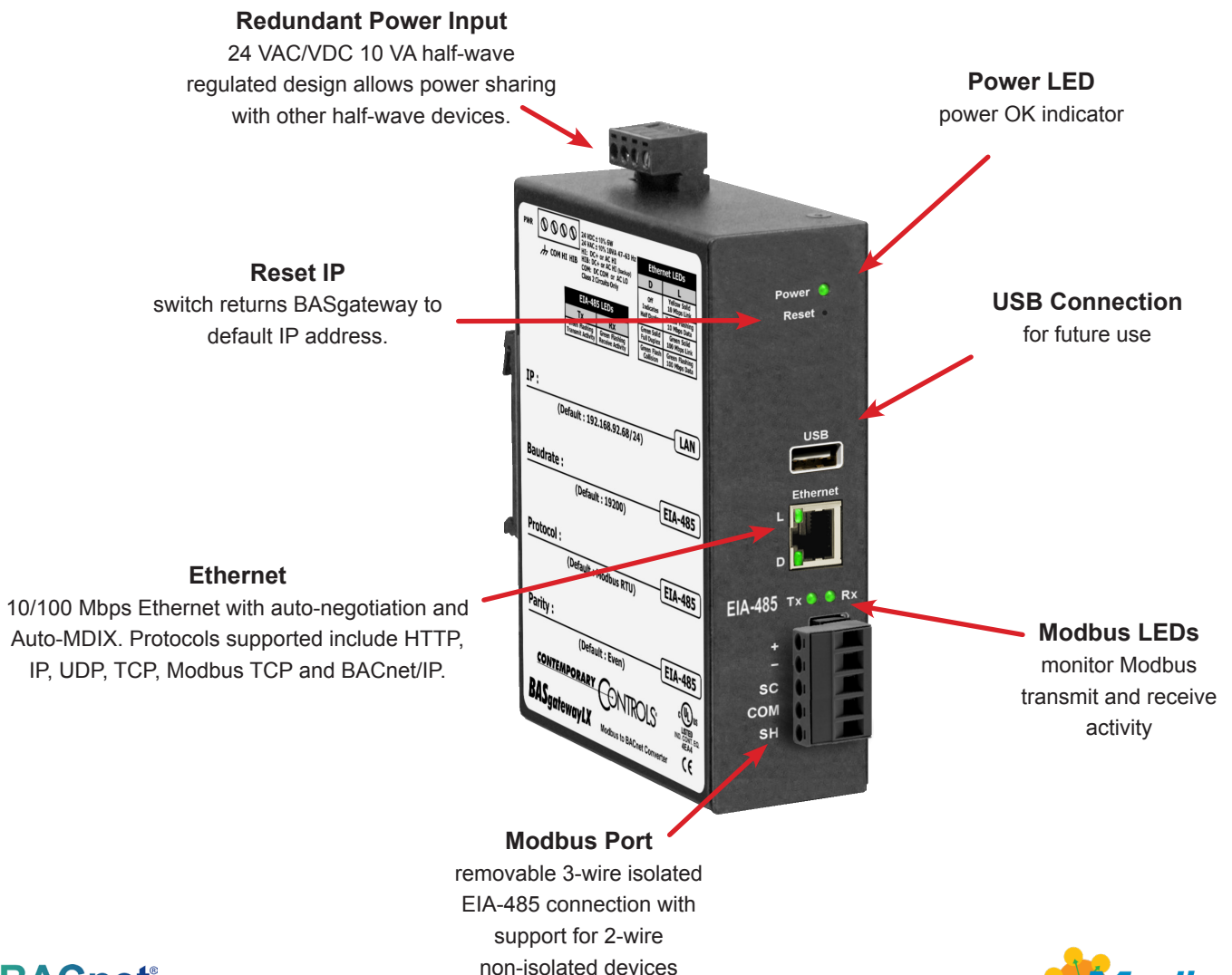

Web Page Configuration



Home
Configure
Mapping Status
Mapping Configuration
Modbus Utility
Upload



Configure Settings

System

System Name:

IP Address:

Subnet Mask:

Gateway Address:

BACnet

Device Instance: (0 - 4194302)

UDP Port: (Hexadecimal value e.g. 0xBAC0)

BBMD IP Address:

BBMD Reg Time: secs

Virtual Network: (1 - 65534)

ReadPropertyMultiple:

Modbus

Baudrate:

Protocol:

Parity:

Command Timeout: (50 - 3,000 msec)

InterScan Delay: (100 - 30,000 msec)

Offline Poll Period: (2,000 - 30,000 msec)

Consecutive RD Delay: (0 - 1,000 msec)

COV Poll Interval: (1000 - 60,000 msec)

About This Page

Use this page to configure the System, Modbus and BACnet settings.

System

System Name: Name your system as you wish.

IP Address: Changing the default value of 192.168.92.68 is recommended.

Subnet Mask: The default value of 255.255.255.0 is adequate for most users.

Gateway Address: If your Ethernet LAN has a gateway or IP router, enter its address here.

BACnet

Device Instance: Enter a unique value (0-4194302) for the BASgatewayLX. Default = 5000.

UDP Port: The default of 0xBAC0 (47808 in decimal) should usually not be changed.

BBMD IP Address: If the local subnet has no BBMD and the BASgatewayLX must pass data to another subnet, it must register as a Foreign Device with a remote BBMD whose address is entered here.

BBMD Reg Time: Specify the time in seconds between successive foreign device registrations.

Virtual Network: Specify a unique network number for devices attached to the BASgateway's EIA-485 port.

ReadPropertyMultiple: Enable or disable read property multiple in BACnet.

Modbus

All devices on the EIA-485 bus must use the same Baudrate, Protocol and Parity.

Baudrate: Choose a value from 2,400 to 115,200. Default = 19,200.

Protocol: Choose RTU or ASCII. Default = RTU.

Parity: Specify NONE 2-Stop-Bit, NONE 1-Stop-Bit, ODD or EVEN. Default = EVEN. When choose NONE 2-Stop-Bit, 2 stop bits are applied.

Onboard Help

each screen includes information that relates to the current view

Configure Settings

all relevant parameters (system + each protocol)

Link to Site

for more information and product support

[Need Support?](#)

Our staff of engineers is available to address any issues you may be having.

Please visit our [product support page](#) for more information.

©2010-2017 Contemporary Control Systems, Inc. All rights reserved.

Web Page Configuration — Continued



Home | Configure | Mapping Status | Mapping Configuration | Modbus Utility | Upload



Mapping Status

Device Instance: 2450142 | Modbus Address: 142

Object Instance: 10: AO : Modbus output register 8

Object Property: Present Value

Property Value: 610

Unit Status
Address 142 Dev 2450142 Online

Check Status
examine device properties and see which devices are online or not

Upload Profile

Select File: No file chosen

Click update after upload the last file

Add a Profile
add device profiles when needed

Modbus Utility

IP Address: 0.0.0.0

Slave Address (1 - 246): 142

Register Number: 400610

Value:

Value Format:
 0X: Coil
 1X: Discrete Input
 3X: Input Reg
 4X: Holding Reg

Value Length:
 32-bit
 64-bit

Data Format:
 Signed Integer
 Unsigned Integer
 Float

Status: 5

Modbus Utility
view coils and read or write data points via web browser

Mapping Configuration

Configured Devices (Max 100): 1

Configured Objects (Max 1000): 1000

Modbus Address	Instance	Name	Type
142	2450142	Click PLC mRTU#142	Test_2_LX_HMS_1000pt

To view changes press Refresh

Add, Alter, Delete
devices with ease

Mapping Configuration

Copy Device

Name: Click PLC mRTU#142

Modbus Address: 142 (1 - 246) | MAX Consecutive RD: 3 (1 - 125)

Modbus IP Address: 0.0.0.0 | Write Code: 6

Device Instance Auto | Region Number: 0 (0 - 9)

Device Instance: 2450142 (0 - 4194302) | MAX Consecutive Errors: 2 (1 - 300)

Modbus Registers (Max 1000):

- 400001 Modbus output register
- 400002 Modbus output register
- 400003 Modbus output register
- 400004 Modbus output register 2
- 400004 Modbus output register
- 400005 Modbus output register
- 400006 Modbus output register
- 400007 Modbus output register
- 400008 Modbus output register
- 400009 Modbus output register
- 400010 Modbus output register 66
- 400011 Modbus output register
- 400012 Modbus output register
- 400013 Modbus output register
- 400014 Modbus output register

Clone Devices
and all their points

Application Information — Using Virtual BACnet Routing

With the BACnet protocol, physical BACnet devices are assigned unique device instances. In this way, any BACnet device within the same BACnet internetwork can be uniquely identified. Accommodations must be made for non-BACnet compliant devices such as Modbus but the ability to uniquely identify each Modbus device within the BACnet internetwork can be retained thanks to the BASgatewayLX and the concept of virtual networking.

The BASgatewayLX has one Modbus serial port that can accommodate up to 100 physical Modbus serial devices. Each one of the attached devices must be configured for the same baud rate, same parity, and same serial protocol – RTU or ASCII. Each device must be assigned a unique slave ID from 1 to 246. In addition, the BASgatewayLX will also support Modbus TCP slave devices attached over Ethernet. The BASgatewayLX functions as a master to all these slave devices. Collectively, all the Modbus TCP and Modbus serial devices are assigned to a virtual BACnet network number during configuration.

Using the concept of virtual BACnet routing, each uniquely addressed Modbus slave device appears as an individual BACnet device with a unique BACnet device instance assignment. Within this BACnet device are a collection of BACnet objects that relate to Modbus data points. What is needed is a device profile for each Modbus device type which allows for the mapping of Modbus data points to BACnet object instances. Contemporary Controls maintains a library of common device profiles with the more popular profiles shipped with the product. Energy meter device

profiles from Veris, Northern Design and Continental Control Systems are part of the library and more are frequently added.

During commissioning, a Modbus device is “added” by selecting the appropriate device profile and assigning a unique BACnet device instance. Each device profile lists all available Modbus data points for a particular Modbus device type along with recommended BACnet object instance designations. A checkbox alongside a data point exists to indicate that this point is to be polled by the BASgatewayLX. By default, the most popular registers in each device profile are marked for polling but the user can add or delete from this list through web pages. Up to 100 edited device profiles can be added each with a unique Modbus slave address and BACnet device instance. Each device profile can be the same or different depending upon the Modbus device type or the amount of points needed to be scanned. The only restriction is the 100 slot limit and the maximum total polled point count of 1000.

Shown below are three device profiles representing three Modbus devices that are to be polled for data while appearing as BACnet devices. Each device has been assigned a unique BACnet device instance. The first two devices are identical and therefore have the same device profile while the third one is a totally different device. Notice that the first two devices have different data points checked demonstrating the flexibility in selecting only those points of interest that need to be polled. When multiple identical devices, such as energy meters, are to be polled — edited device profiles can be copied to further speed commissioning.

Device Name: Veris A

Modbus Address: 40 (1 to 246)

Modbus IP Address: 0.0.0.0

Device Instance: 2450040

Modbus Registers (Max 1000):

- 400271 Avg Voltage L-N average of 3
- 400273 Avg Current average of 3
- 400275 Real Power phase A
- 400277 Real Power phase B
- 400279 Real Power phase C
- 400281 Power Factor phase A
- 400283 Power Factor phase B
- 400285 Power Factor phase C

Device Name: Veris B

Modbus Address: 41 (1 to 246)

Modbus IP Address: 0.0.0.0

Device Instance: 2450041

Modbus Registers (Max 1000):

- 400271 Avg Voltage L-N average of 3
- 400273 Avg Current average of 3
- 400275 Real Power phase A
- 400277 Real Power phase B
- 400279 Real Power phase C
- 400281 Power Factor phase A
- 400283 Power Factor phase B
- 400285 Power Factor phase C

Device Name: ND350

Modbus Address: 10 (1 to 246)

Modbus IP Address: 0.0.0.0

Device Instance: 2450010

Modbus Registers (Max 1000):

- 400513 eScale Energy Register
- 400515 kWh Energy Register
- 400517 kVAh Energy Register
- 400519 kvarh Inductive Energy Register
- 400521 kvarh Capacitive Energy Register
- 400523 Import kvarh Energy Register
- 400525 Export kWh Energy Register
- 400527 Export kvarh Energy Register

Application Information — Tips on Configuration

The BASgatewayLX is shipped with a default private IP address of 192.168.92.68 /24. Once its internal web server can be reached with any standard web browser for configuration, status, and Modbus utility operations. HTML web pages allow cross-platform compatibility and browser support. There are three sections that must be addressed once the Configure Settings tab is clicked.

System

Eventually, the default IP address and subnet mask will need to be changed but if this data is ever lost, it is possible to reset the IP address to its default settings without losing any other configuration data. The installer can choose a name for the BASgatewayLX. If there is an IP router on the attached Ethernet network, provide its IP address as the Gateway Address when configuring the System settings.

BACnet

The BASgatewayLX must be assigned a unique device instance number independent from any other assignments. The UDP port is typically the default registered BACnet port 0xBAC0. Only under special circumstances this needs to be changed.

If the BASgatewayLX is to be installed on a subnetted BACnet internetwork, it will be necessary for the BASgatewayLX to register as a Foreign Device with a BACnet/IP Broadcast Management Device (BBMD) if none exists on the BASgatewayLX's subnet. If this is the case, enter the IP address of a known BBMD thereby invoking Foreign Device Registration with this BBMD. This is why the Gateway Address must be entered in the system settings. By registering as a foreign device, the

BASgatewayLX will be able to receive broadcast messages originating from other subnets. A BBMD registration time must be entered so that registration is continuously renewed on a periodic basis.

The final setting is the Virtual Network address. This is the unique BACnet network number assigned to the attached Modbus devices.

Modbus

The last section in the Configure Settings screen deals only with Modbus serial devices. The first decision is to select a baud rate between 2400 and 115200 although 19200 is the default. The next is to select Modbus RTU or Modbus ASCII. Modbus RTU is much more popular and is the default. Next is the Parity setting and it is recommended to pick NONE although EVEN is the default. If no parity is selected, an extra STOP bit is added automatically so as to not change the frame length. Whatever settings are used, they MUST apply to ALL attached Modbus devices.

There are other settings that should not be touched unless for good cause. Time settings are in milliseconds. Command Timeout is the time the master waits for a response from a slave. The Inter Scan Delay is the time between each polling cycle. The Offline Poll Period is the time the master will wait before trying to contact an offline slave. The Consecutive RD Delay is the amount of time the master waits when polling the same device with consecutive reads. If the slave device is capable of responding to a block read of consecutively numbered points, the Max Consecutive RD can be limited by this number.

Mapping Modbus Points to BACnet

Modbus data is considered to be segregated into four memory blocks — coils, discrete inputs, input registers and holding registers. Discrete inputs and coils are considered to be 1-bit points while input registers and holding registers are 16-bit points. Therefore 1-bit points would be assigned either a BACnet BI or BO object type while 16-bit points would become either an AI or AO. If the point was read-only, then it would be considered a BACnet input. All read/write points would be considered outputs. Using this convention, the following mapping rules apply when generating device profiles:

Modbus Coils become BOs or BIs depending on how they are defined in the Modbus profile

Modbus Discrete Inputs become BIs

Modbus Input Registers become AIs

Modbus Holding Registers become AOs or AIs depending on how they are defined in the Modbus profile

There is an exception to these rules. It is possible that a holding register is packed as individual status bits or control points that need to be extracted. When generating the device profile, they are broken out as individual BOs or BIs instead of one AO. Object instance numbers are then assigned sequentially for each identified Modbus point.

Application Information — Managing Modbus Devices

Once the BASgatewayLX is properly configured, Modbus device profiles can be added for each attached Modbus device. The process for adding devices is similar for Modbus Serial or Modbus TCP devices.

Adding a Device

By clicking on the Mapping Configuration tab you will be presented with a Configured Devices box showing all Modbus devices that are currently being assessed by the BASgatewayLX. Clicking on any of the devices listed will show you a Device Information box showing the device profile of that particular device. The device profile lists all available Modbus points with each entry having a box along side. A checked box means that the associated point is being included in the BASgatewayLX's scan list.

When viewing the Configured Devices box, a Modbus device can be added by clicking the Add button. From the drop-down Device Profile menu select the appropriate device profile for the device to be added. You will notice the selected profile with pre-checked boxes was added. You can add or delete those points of interest at any time before submitting the device to the scan list. Next assign the Modbus slave address from 1-246. If the device is Modbus serial device, leave the Modbus IP Address at its default 0.0.0.0 setting. If the device is a Modbus TCP device, enter its IP address as well as its slave address. If the Modbus TCP device is on a different subnet to that of the BASgatewayLX, communications is possible if IP routers are installed on the respective subnets.

A unique BACnet device instance number will need to be assigned to each connected Modbus device and the BASgatewayLX has a scheme to make assignments easier. Notice that the Device Instance Auto box is checked meaning that the BASgatewayLX will attempt to automatically assign unique BACnet device instances to each BASgatewayLX being installed. The 7-digit format uses 245 as the leading number which is Contemporary Controls BACnet vendor ID. The following digit is determined by the Region Number which can range from 0 to 9. The final digits are the Modbus slave address. If there is only one BASgatewayLX within the BACnet internetwork, then there is no need to increment the Region Number from its default value of zero. If more than one BASgatewayLX is being used in the same system, increment the Region Number for each added BASgatewayLX up to 9 to be sure no duplicate BACnet device instances are generated. Above 10 BASgatewayLXs it will be

necessary to enter the BACnet device instance manually. Uncheck the Device Instance Auto box and enter a unique number from 0 to 4194302. To complete configuration, you can enter a name for the device you added on the top line. Once all entries are made press Submit and then Back to return to the Configured Devices box. Once there, refresh the box and you will see your new device.

Modifying, Copying and Deleting Devices

From the Configured Devices box you have the capability to modify settings in a device, copy a device if multiple instances of the same device are to be used — and finally, you can delete a device.

Mapping Status

By clicking on Mapping Status you can determine the number of Modbus devices that are online by observing the Unit Status box. To view a particular device, go to the Device Instance drop-down box and select the device of interest. Its Modbus address will automatically appear to the right of the device instance. Modbus TCP devices will appear as a combination of IP address and Modbus slave address. Using the Object Instance drop-down box you can scroll through all the objects that are being polled within that device. The first reference is the actual BACnet object instance which is followed by the object instance type (AI, AO, BI or BO). The last reference is the Modbus point. After selecting one of the objects, an object property can be selected through the Object Property drop-down. The more interesting property would be the Present Value of the object. The present value of all objects can be read by clicking on the Read button but not all objects can be written by supplying a value and clicking on the Write button. If the object property cannot be written, the Write button will be greyed out.

Upload Profile

Standard device profiles come with the device but new ones are continuously being developed. Newly developed profiles will be posted on the BASgatewayLX product support page which can be found on <http://www.ccontrols.com>. In addition, Contemporary Controls will develop or modify an existing device profile based upon a customer's request. Wherever the source of the new or modified device profile, it must first be loaded onto the customer's computer and then it can be uploaded to the BASgatewayLX following instructions under the Upload Profile tab.

Application # 1 — Two Virtual Networks

The most common application is adding one or more Modbus serial networks to a BACnet system. Each Modbus serial network must be configured for the same Modbus serial protocol (RTU or ASCII), the same data rate (2400–115200 baud), and the same parity (ODD, EVEN or NONE). Make sure any wiring issues with 2-wire and 3-wire devices are addressed. With the system shown as below, two virtual

BACnet networks must be assigned — network 1 and network 2 — which are separate from the real BACnet network numbered as 3 in this example. If you are using the Device Instance Auto feature to automatically assign device instances, you must select a different Region Number for the two BASgatewayLXs to ensure that no duplicate device instances are generated.

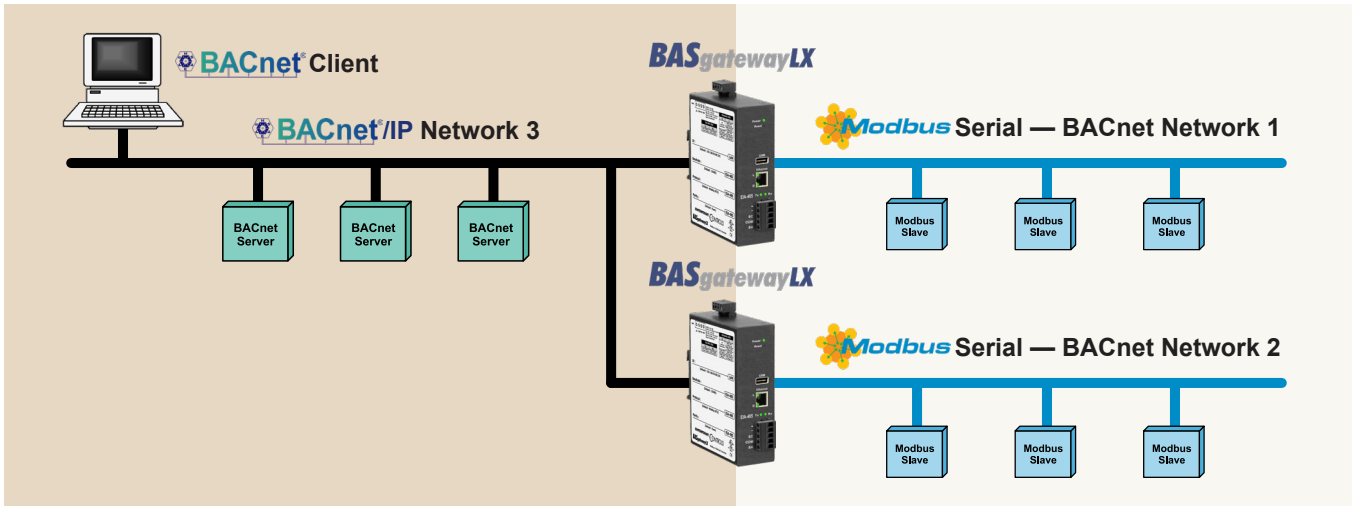

Application # 2 — Mixing Modbus TCP and Modbus Serial

The BASgatewayLX can handle both Modbus TCP devices and Modbus RTU devices simultaneously using just one BASgatewayLX as long as the 100 device/1000 polled point limit is maintained. In this application the Modbus TCP connection is called a “one-armed gateway” because both Modbus TCP and BACnet/IP messages transfer through the same Ethernet port. Configuration is similar to that of a Modbus serial device. However, this time the IP address of

the Modbus TCP device must be entered as well as a Modbus slave address. A potential conflict could exist when using the Device Instance Auto feature and an attached Modbus TCP device and an attached Modbus Serial device happen to use the same slave address. If a conflict is reported by the BASgatewayLX, simply set the device instance manually — or select a different Region Number.

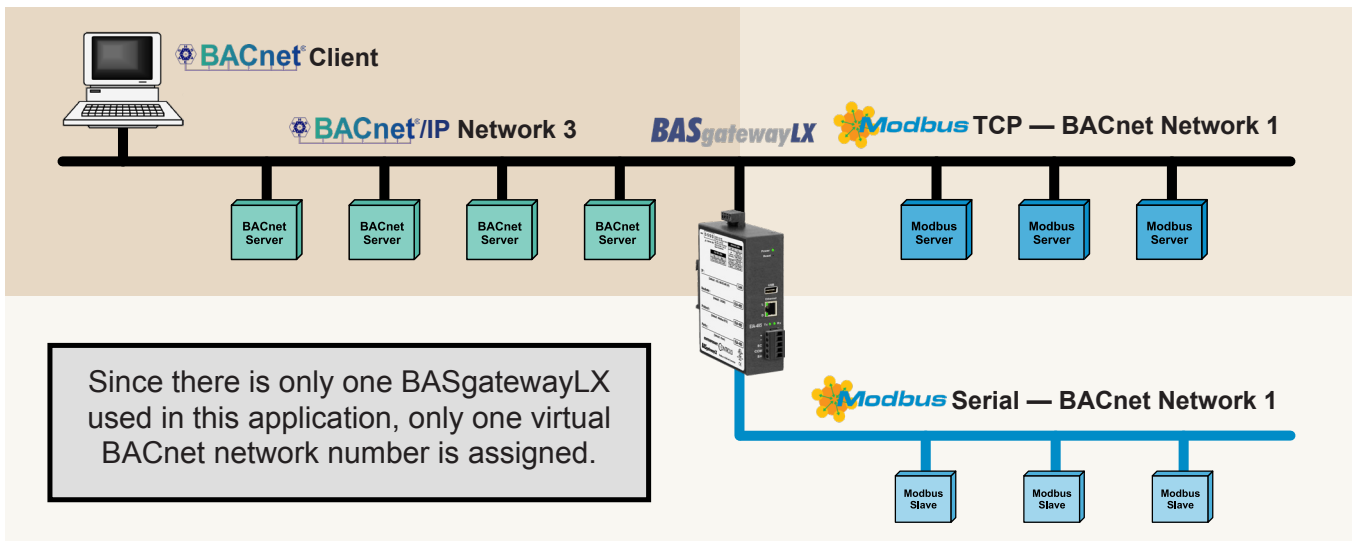

Application # 3 — Modbus Serial to Modbus TCP Routing

Inherently, the BASgatewayLX will function as a Modbus serial to Modbus TCP router. In this mode no mapping configuration is needed since BACnet is not involved. Modbus TCP devices can function as clients, servers or client/servers. When a Modbus TCP server device is configured, it must be assigned a slave address as well as an IP address. When a Modbus TCP client accesses a

Modbus TCP server, communications occurs over Ethernet with no involvement with the BASgatewayLX. However, if a Modbus TCP client communicates with a Modbus serial device, the message is routed through the BASgatewayLX to its serial bus. For this application, no configuration is required other than the *System* and *Modbus* settings under the Configure Settings tab.

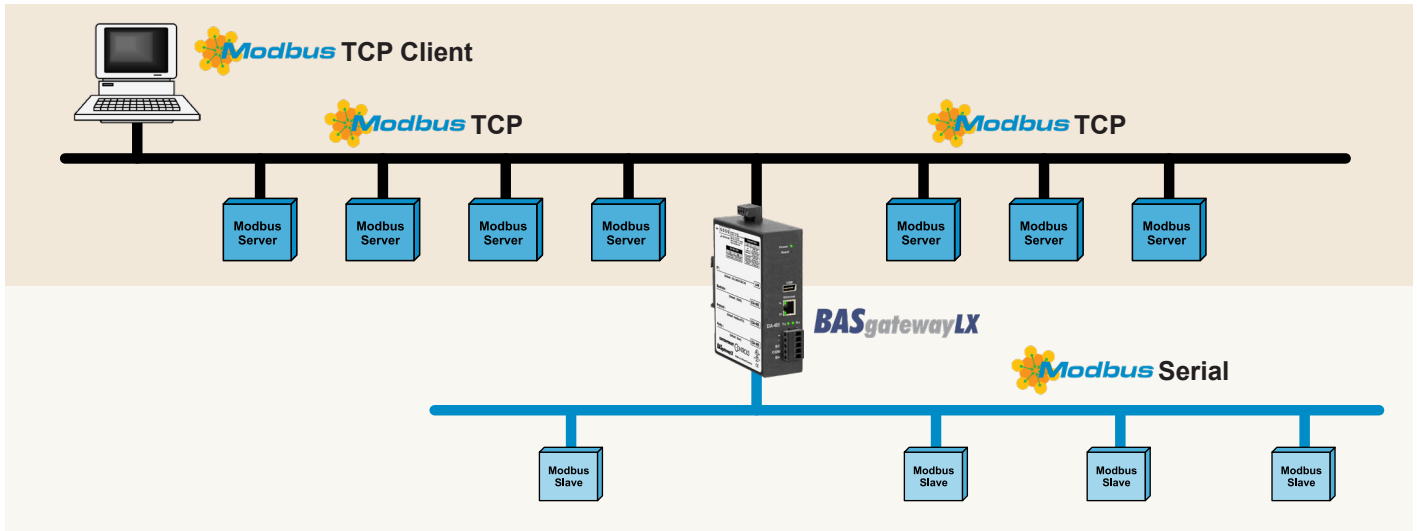

Application # 4 — Subnetted IP Network

With IP networks, it is possible that BACnet client devices, the BASgatewayLX and Modbus TCP devices may all reside on different subnets interconnected through IP routers. The BASgatewayLX will still operate under these conditions. Shown below are a BACnet client with BBMD capability and Modbus TCP servers on subnet 1 with the BASgatewayLX and other Modbus TCP servers on subnet 2. Attached to the BASgatewayLX serial port are Modbus serial devices.

Between the two subnets is an IP router. Enable foreign device registration in the BASgatewayLX by setting its *BBMD IP Address* field to the IP address of the BACnet client. In the BASgatewayLX's *System* setup, set the *Gateway Address* to the IP address of the IP router. Modbus TCP and Modbus serial devices are entered as normal — allowing the BACnet client (or other BACnet clients) to discover all Modbus devices without issue.

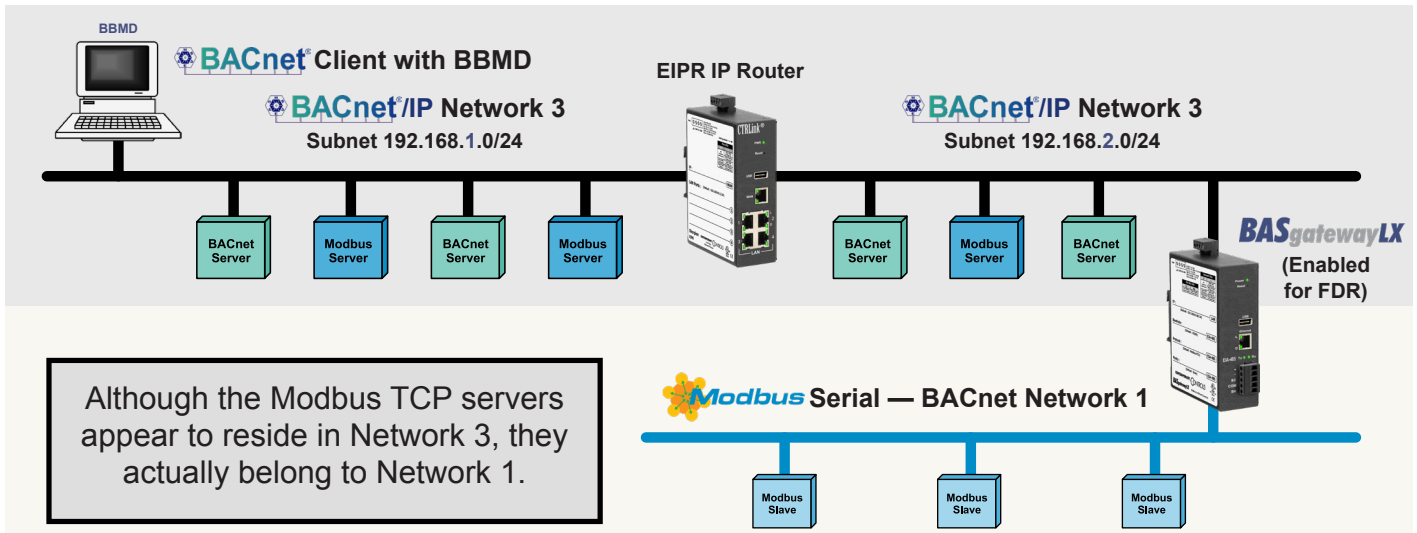

BACnet Protocol Implementation Conformance (PIC) Statement



BASgatewayLX Modbus to BACnet® Converter

BACnet Protocol Implementation Conformance Statement (Annex A)

Date: March 1, 2013
Vendor Name: Contemporary Controls
Product Name: BASgatewayLX
Product Model Number: BASGLX-M1
Applications Software Version: 1.2.0 **Firmware Revision:** 1.2.0 **BACnet Protocol Revision:** 6
Product Description: Gateway between Modbus and BACnet.

BACnet Standardized Device Profile (Annex L):

- | | |
|-----------------------------------------------------------------------|------------------------------------------------------------------------------------|
| <input type="checkbox"/> BACnet Operator Workstation (B-OWS) | <input type="checkbox"/> BACnet Advanced Application Controller (B-AAC) |
| <input type="checkbox"/> BACnet Advanced Operator Workstation (B-AWS) | <input checked="" type="checkbox"/> BACnet Application Specific Controller (B-ASC) |
| <input type="checkbox"/> BACnet Operator Display (B-OD) | <input type="checkbox"/> BACnet Smart Sensor (B-SS) |
| <input type="checkbox"/> BACnet Building Controller (B-BC) | <input type="checkbox"/> BACnet Smart Actuator (B-SA) |

List all BACnet Interoperability Building Block Supported (Annex K):

- | | |
|--------------------------------------------------|---------------------------------------------------------------|
| DS-RP-B Data Sharing — ReadProperty – B | DM-DDB-B Device Management — Dynamic Device Binding – B |
| DS-WP-B Data Sharing — WriteProperty – B | DM-DOB-B Device Management — Dynamic Object Binding – B |
| DS-RPM-B Data Sharing — ReadPropertyMultiple – B | DM-DCC-B Device Management — Device Communication Control – B |
| DS-COV-B Data Sharing — ChangeOfValue – B | DM-TS-B Device Management — Time Synchronization – B |

Segmentation Capability:

- Able to transmit segmented messages Window Size:
 Able to receive segmented messages Window Size:

Standard Object Types Supported:

Object Type Supported	Can Be Created Dynamically	Can Be Deleted Dynamically
Analog Input	No	No
Analog Output	No	No
Binary Input	No	No
Binary Output	No	No
Device	No	No

No optional properties are supported.

Data Link Layer Options:

- | | |
|------------------------------------------------------------------------------|-----------------------------------------------------------------------------|
| <input checked="" type="checkbox"/> BACnet IP, (Annex J) | <input type="checkbox"/> MS/TP slave (Clause 9), baud rate(s): |
| <input checked="" type="checkbox"/> BACnet IP, (Annex J), Foreign Device | <input type="checkbox"/> Point-To-Point, EIA 232 (Clause 10), baud rate(s): |
| <input type="checkbox"/> ISO 8802-3, Ethernet (Clause 7) | <input type="checkbox"/> Point-To-Point, modem, (Clause 10), baud rate(s): |
| <input type="checkbox"/> ATA 878.1, 2.5 Mb. ARCNET (Clause 8) | <input type="checkbox"/> LonTalk, (Clause 11), medium: |
| <input type="checkbox"/> ATA 878.1, EIA-485 ARCNET (Clause 8), baud rate(s): | <input type="checkbox"/> BACnet/Zigbee (Annex O) |
| <input type="checkbox"/> MS/TP master (Clause 9), baud rate(s): | <input type="checkbox"/> Other: |

Device Address Binding:

Is static device binding supported? (This is currently necessary for two-way communication with MS/TP slaves and certain other devices.) Yes No

Networking Options:

- Router, Clause 6 — List all routing configurations, e.g., ARCNET-Ethernet, Ethernet-MS/TP, etc.
 Annex H, BACnet Tunnelling Router over IP
 BACnet/IP Broadcast Management Device (BBMD)
 Does the BBMD support registrations by Foreign Devices? Yes No
 Does the BBMD support network address translation? Yes No

Character Sets Supported:

Indicating support for multiple character sets does not imply that they can all be supported simultaneously.
 ISO 10646 (UTF-8) IBM™/Microsoft™ DBCS ISO 8859-1
 ISO 10646 (UCS-2) ISO 10646 (UCS-4) JIS X 0208

If this product is a communication gateway, describe the types of non-BACnet equipment/network(s) that the gateway supports:
 Modbus gateway support.

Network Security Options:

- Non-secure Device — is capable of operating without BACnet Network Security
 Secure Device — is capable of using BACnet Network Security (NS-SD BIBB)
 Key Server (NS-KS BIBB)

Wiring Diagrams

Since the product incorporates a half-wave rectifier circuit, it can share the same 24 VAC power with other half-wave rectified devices. It can also be powered from a 24 VDC source. A redundant power connection exists (HIB) for back-up power schemes.

The product incorporates a 3-wire optically-isolated EIA-485 interface for the serial connection, allowing better circuit protection and noise immunity. To connect to other 3-wire devices simply make a one-to-one connection to the other devices. But when connecting to

2-wire non-isolated devices, the signal common (SC) on the product must share the reference used by the 2-wire devices. This is accomplished by tying the SC pin to COM on the product and by grounding the low-side of each power supply on all connected devices. In this way all EIA-485 transceivers share the same earth reference. Notice that the SC pin is signal common and not a shield pin. For shield connections, use the SH pin. Far-end external termination is required as shown. Near-end bias and termination are internally supplied within the product.

3-wire Modbus Network

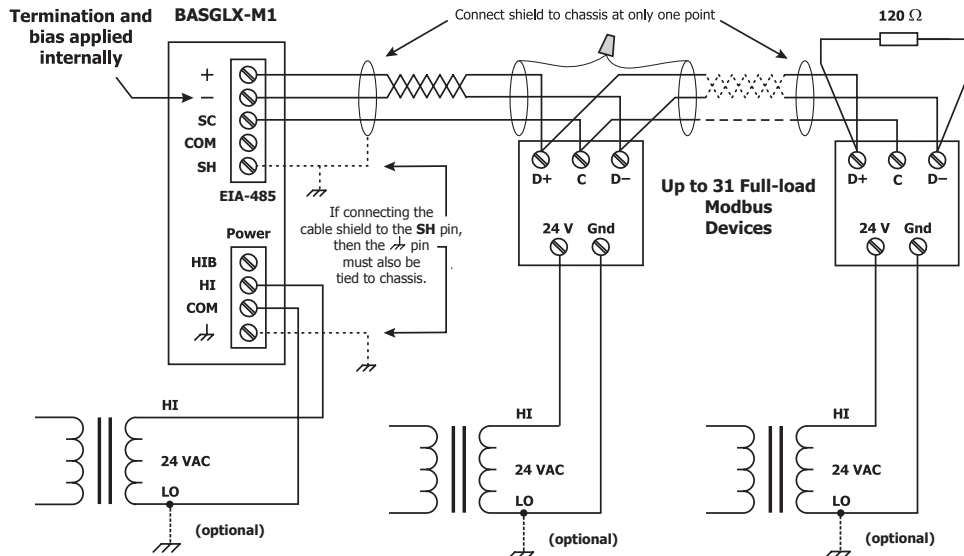

2-wire Modbus Network

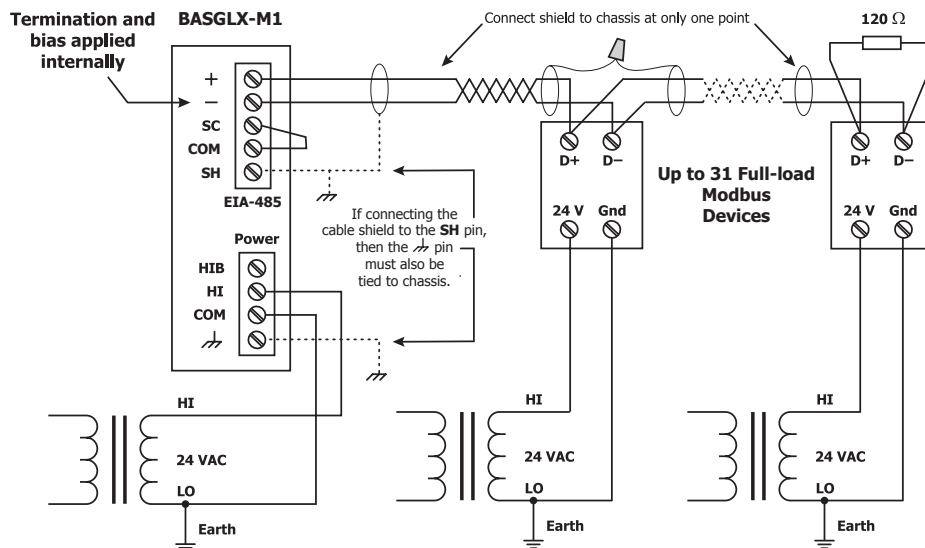

Connector Pin Assignments

Ethernet

Pin	Function
1	TD+
2	TD-
3	RD+
4	N/C
5	N/C
6	RD-
7	N/C
8	N/C

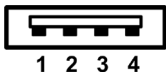
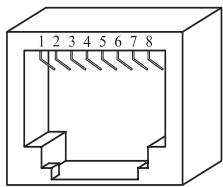

EIA-485

Pin	Function
+	Signal High
-	Signal Low
SC	Signal Common
COM	0V
SH	Shield (Chassis)

Power

Pin	Function
HIB	Redundant Power
HI	DC+ or AC High
COM	0V or AC Low
	Chassis

USB

Pin	Function
1	+5V
2	-Data
3	+Data
4	Ground

Mechanical Drawings

DIN-Rail

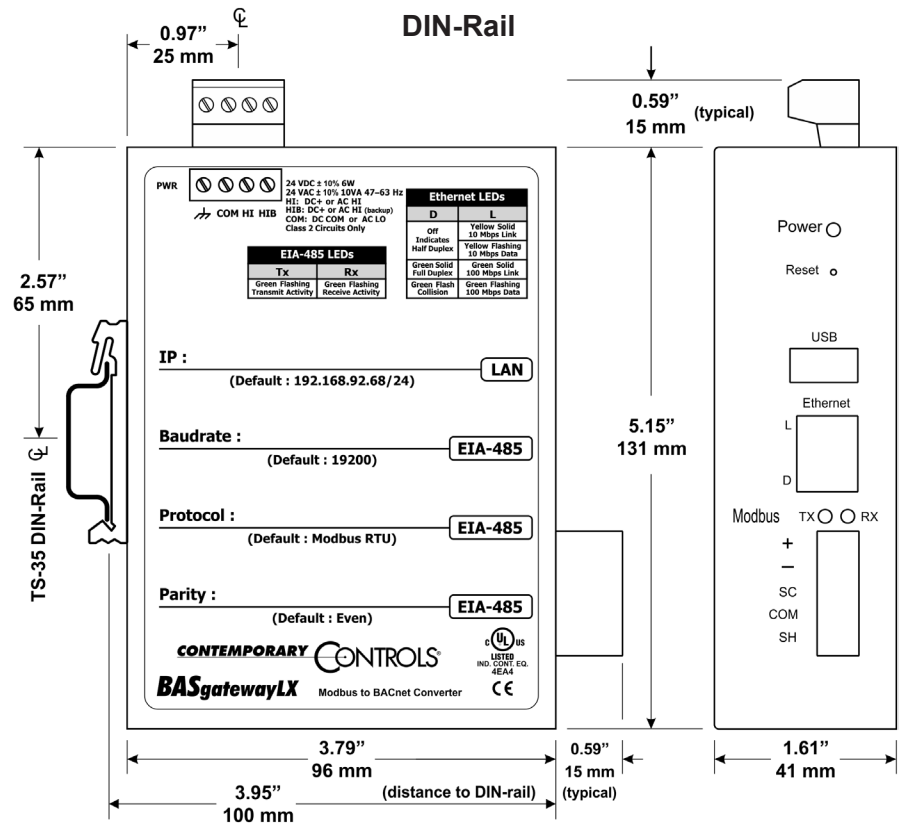

Panel Mount

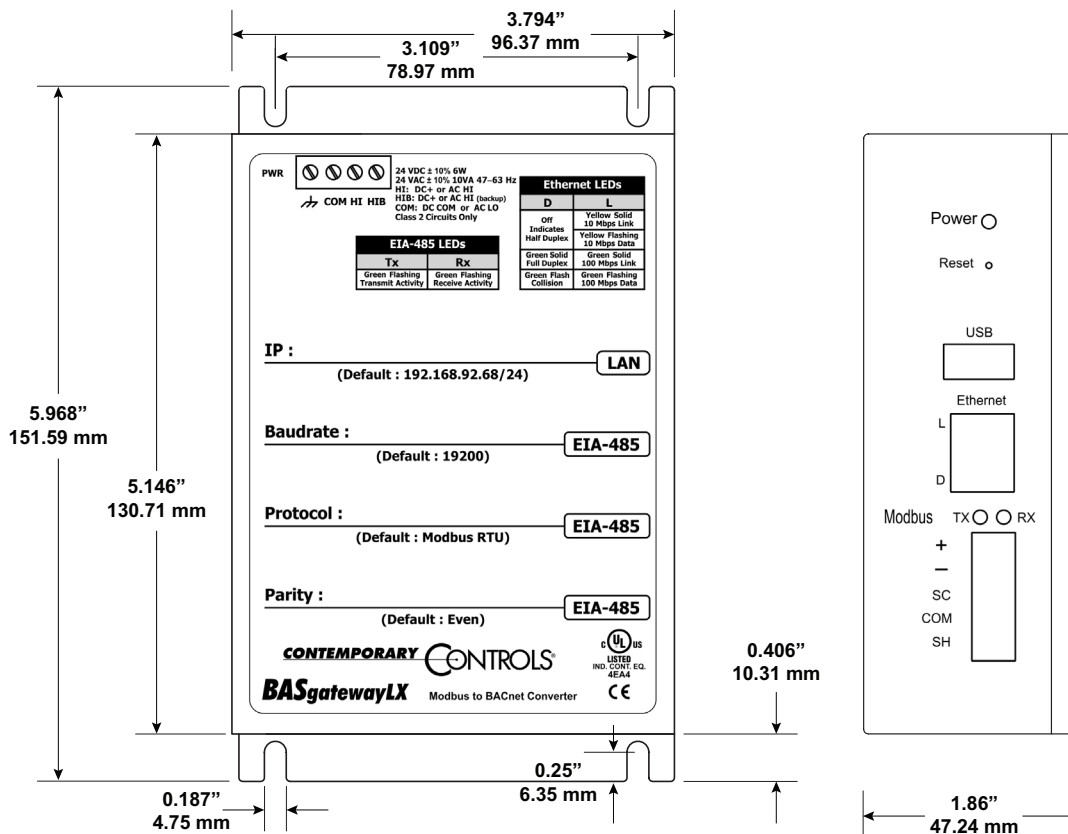

Specifications

Power Requirements 24 VAC ±10% 10 VA 47–63 Hz or 24 VDC ±10% 6 W

Operating Temperature 0°C to 60°C

Storage Temperature -40°C to 85°C

Relative Humidity 10–95%, non-condensing

Protection IP30

USB Port USB 2.0, Type A

Communication

Compliance
Protocols supported

Data rate
Physical layer
Cable length (max)
Port connector

LEDs

Ethernet

IEEE 802.3
Modbus TCP
BACnet/IP
10 Mbps, 100 Mbps
10BASE-T, 100BASE-TX
100 m
Shielded RJ-45

L (Link)

Green = 100 Mbps
Yellow = 10 Mbps
Flash = activity

D (Duplex)

Green = Full-duplex
Off = Half-duplex
Flash = Collision

EIA-485

Modbus V1.02
RTU Master
ASCII Master
2.4, 4.8 9.6, 19.2, 38.4, 57.6, 115.2 kbps
EIA-485, 3-wire isolated
1200 m (or 1000 m if using 115.2 kbps)
5-pin removable terminal

Tx

Green = activity

Rx

Green = activity

Regulatory Compliance CE Mark; CFR 47, Part 15 Class A; RoHS
UL 508; C22.2 No. 142-M1987



Ordering Information

Model	RoHS	Description
BASGLX-M1	✓	BASgatewayLX Modbus to BACnet Gateway DIN-Rail Mount
BASGLX-M1/P	✓	BASgatewayLX Modbus to BACnet Gateway Panel Mount

United States

Contemporary Control
Systems, Inc.

Tel: +1 630 963 7070
Fax: +1 630 963 0109

info@ccontrols.com

China

Contemporary Controls
(Suzhou) Co. Ltd

Tel: +86 512 68095866
Fax: +86 512 68093760

info@ccontrols.com.cn

United Kingdom

Contemporary Controls Ltd

Tel: +44 (0)24 7641 3786
Fax: +44 (0)24 7641 3923

ccl.info@ccontrols.com

Germany

Contemporary Controls GmbH

Tel: +49 341 520359 0
Fax: +49 341 520359 16

ccg.info@ccontrols.com

www.ccontrols.com